

Construction

Submersible borehole pumps for 6" wells (DN 150 mm), 8" (DN 200 mm) and 10" (DN 250 mm), with stages in cast iron or in bronze, on request.

Impellers: - mixed flow impellers.

Connection: - screwed connection ISO 228 for 6SDS;
- flange with counter-flange for welding for 8SDS and 10SDS

Delivery casing with built-in non-return valve.

Applications

For water supply.
For civil and industrial applications.
For fire fighting applications.
For irrigation.

Operating conditions

Liquid temperature up to a 25 °C.
Max. sand quantity into the water: 150 g/m³ (300 g/m³ high percentage of solids and sand).
Continuous duty.

Rewindable motor CS-R series

2-pole induction motor, 50 Hz (n ≈ 2900 rpm).
With water wetted winding in rewindable execution.
Sized for connection to the pumps according to NEMA Standards.
Standard voltages:
- single-phase 230 V - up to 2,2 kW for 4" motors.
- three-phase 230 V; 400 V for 4" motors.
- three-phase 400 V; 400/690 V for 6-8-10" motors.
Voltage tolerance : ± 10%.

In order to limit both current and torque at each starting, for rated motor powers equal to or higher than 7.5kW, one of the following types of starting is necessary: star/delta, soft starter, stator impedance or autotransformer.

Insulation class:
- class F for 4" motors,
- class E for 6" motors, PVC for I-6" (I-6" 45 kW A (PE2+PA)).
- PVC for 8"
- PVC for 10" (10" 170kW and 190 kW A (PE2+PA))

Protection IP 68.
Installation below water level: 200 m for 4", 150 m for 6", 500 m for 8,10"
Motor suitable operation with frequency converter (with suitable filter dv/dt).
Horizontal installation (6" 37-45kW, 8" 92kW, 10" 170-190 kW excluded).
Continuous duty.

Special features on request

- Other voltages.
- 60 Hz frequency.
- Other temperatures.
- Encapsulated motor **FK series**.

Designation

B 10 SDS 190 / 6

Bronze construction (on request)

Ø of the well in inches _____

Series _____

Stage identification _____

Number of stages _____

Materials

Components	Part Nr.	6, 8, 10SDS	B-6, B-8, B-10SDS
Stage casing	25.02	Cast iron GJL 200 EN 1561	Bronze G-Cu Sn 10 EN 1982
Diffuser	26.00		
Impeller	28.00		
Wear ring		Rubber (Bronze for 10SDS 190-280)	
Shaft	64.00	Steel AISI F51duplex	
Shaft sleeve	64.08	Brass with chromate surface treatment (only for 10SDS)	
Delivery casing	12.01	Cast iron GJL 200 EN 1561	Bronze G-Cu Sn 10 EN 1982
Suction lantern	32.02		
Bearing bush	12.03-12.30	Rubber	
Strainer	15.50	Cr-Ni steel AISI 304	
Screws		Cr-Ni steel AISI 304	

CS-R Motor

Components	CS-R 6", 8", 10" standard	I-CS-R 6", 8", 10" AISI 316
External frame	Cr-Ni steel AISI 304 (Steel AISI 316 for 6")	Cr-Ni-Mo steel AISI 316
Motor flange	Cast iron GJL 250 EN 1561 (Cast iron G 25 EN 1561 for 8,10")	Cr-Ni-Mo steel AISI 316
Shaft end	Cr-Ni steel AISI 431 (Steel AISI 630 for 10")	Duplex 1.4462 (Steel AISI 630 for 8,10")
Thrust bearing	Brass pads	Brass pads

Coverage chart $n \approx 2900$ rpm

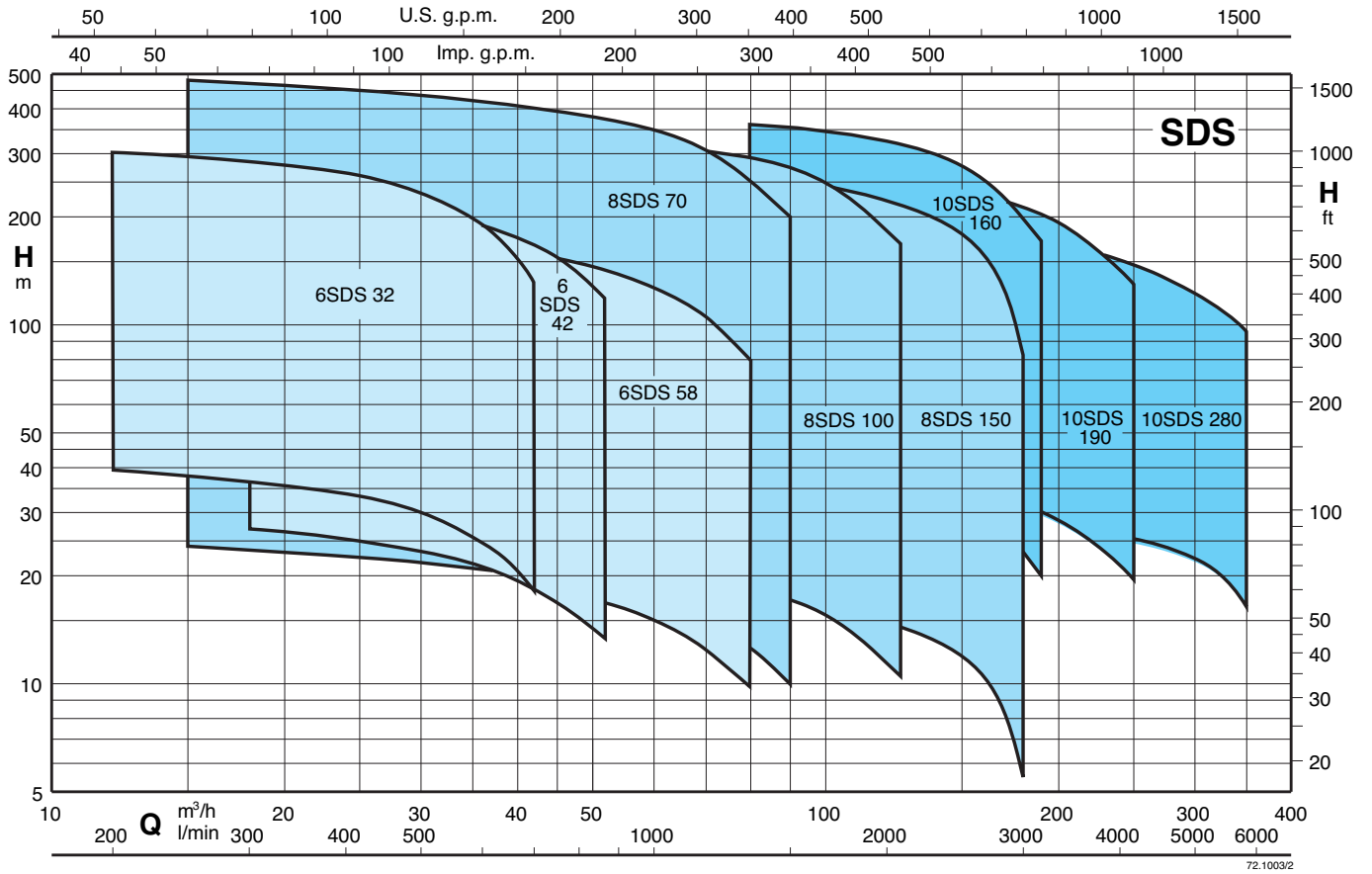

Characteristic curves, performance $n \approx 2900$ rpm, dimensions and weights

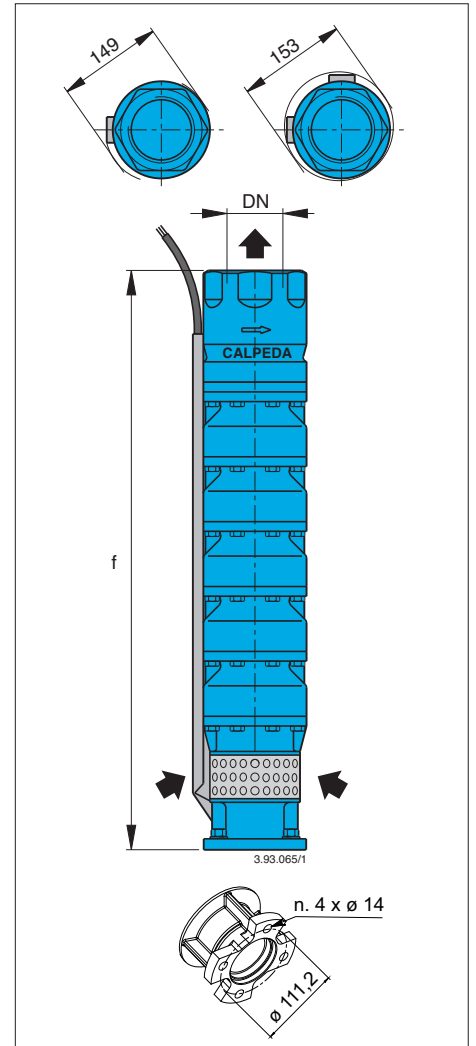
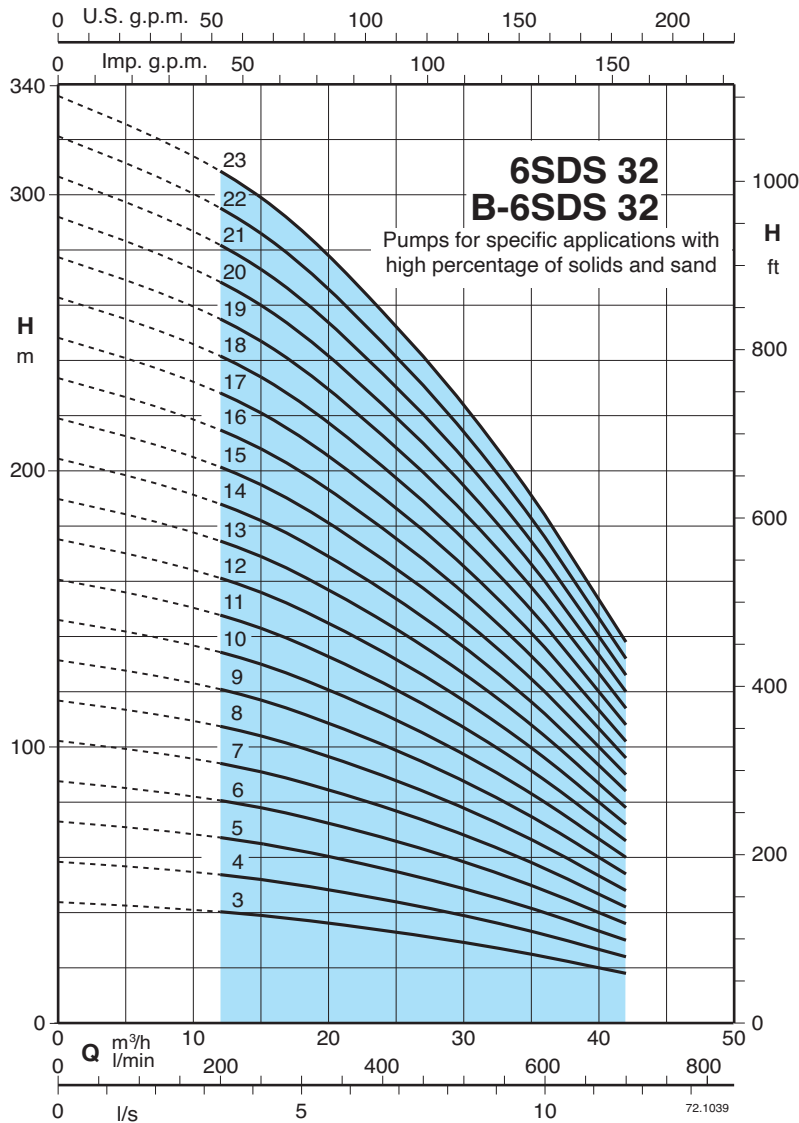

3 ~	P ₂		Q	n ≈ 2900 rpm										
				H m										
	kW	HP		m³/h	12	18	21	24	27	30	33	36	39	42
6SDS 32/3 - B-6SDS 32/3	4	5,5	39	37	35,5	33,5	31,5	30	26,5	24	21	18		
6SDS 32/4 - B-6SDS 32/4	5,5	7,5	52	49	47	45	42	39,5	35,5	32	28	24		
6SDS 32/5 - B-6SDS 32/5	7,5	10	65	61,5	59	56	52,5	49,5	44,5	40	35	30		
6SDS 32/6 - B-6SDS 32/6	7,5	10	78	74	71	67	63	59,5	53,5	48	42	36		
6SDS 32/7 - B-6SDS 32/7	9,2	12,5	92	86	82,5	78,5	73,5	69	62	56	49	42		
6SDS 32/8 - B-6SDS 32/8	11	15	105	98,5	94,5	89,5	84	79	71	64	56	48		
6SDS 32/9 - B-6SDS 32/9	13 (15)	17,5 (20)	118	111	106	101	94,5	89	80	72	63	54		
6SDS 32/10 - B-6SDS 32/10	13 (15)	17,5 (20)	131	123	118	112	105	99	89	80	70	60		
6SDS 32/11 - B-6SDS 32/11	15	20	144	135	130	123	115	109	98	88	77	66		
6SDS 32/12 - B-6SDS 32/12	15	20	157	147	141	134	126	119	107	96	84	72		
6SDS 32/13 - B-6SDS 32/13	18,5	25	170	160	153	145	136	129	116	104	91	78		
6SDS 32/14 - B-6SDS 32/14	18,5	25	183	172	165	157	147	138	124	112	98	84		
6SDS 32/15 - B-6SDS 32/15	22	30	196	184	177	168	157	148	133	120	105	90		
6SDS 32/16 - B-6SDS 32/16	22	30	209	197	189	179	168	158	142	128	112	96		
6SDS 32/17 - B-6SDS 32/17	22	30	223	209	200	190	178	168	151	136	119	102		
6SDS 32/18 - B-6SDS 32/18	26 (30)	35 (40)	236	221	212	201	189	178	160	144	126	108		
6SDS 32/19 - B-6SDS 32/19	26 (30)	35 (40)	246	234	224	213	199	188	169	152	133	114		
6SDS 32/20 - B-6SDS 32/20	26 (30)	35 (40)	262	246	236	224	210	198	178	160	140	120		
6SDS 32/21 - B-6SDS 32/21	26 (30)	35 (40)	275	258	248	235	220	208	187	168	147	126		
6SDS 32/22 - B-6SDS 32/22	30	40	288	270	259	246	231	218	196	176	154	132		
6SDS 32/23 - B-6SDS 32/23	30	40	301	283	271	257	241	228	205	184	161	138		

DN	f	6SDS	B-6SDS
	mm	kg	kg
G 3 ISO 228	686	30,5	35,5
	788	35,6	41,6
	890	41	49
	992	46	55
	1094	52,3	62,3
	1196	57	68
	1298	62,5	74,5
	1400	68,5	81,5
	1502	72,5	86,5
	1604	77,5	93,5
	1706	84	101
	1808	89	108
	1910	94,2	112
	2012	100	119
	2114	105	125
2216	111	132	
2318	116	139	
2420	122	145	
2522	127	151	
2624	132	157	
2726	137	164	

Characteristic curves, performance $n \approx 2900$ rpm, dimensions and weights

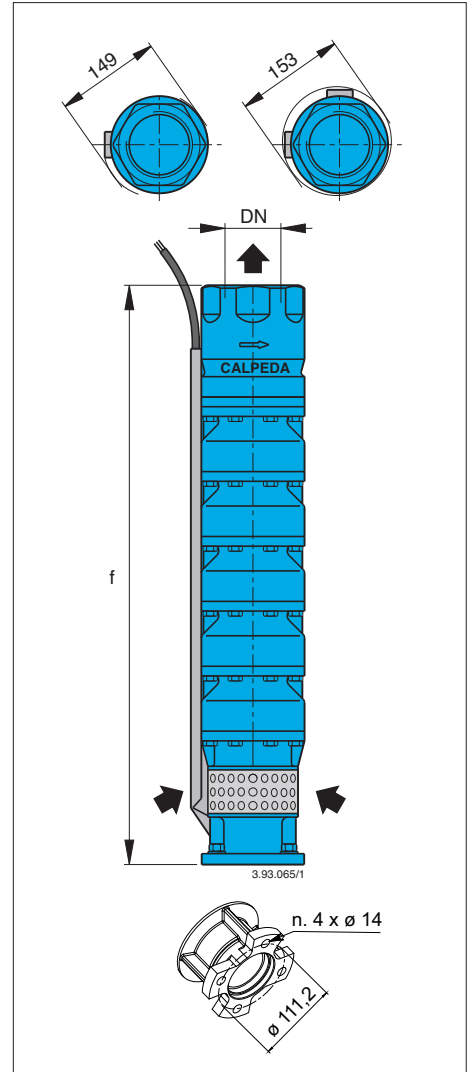
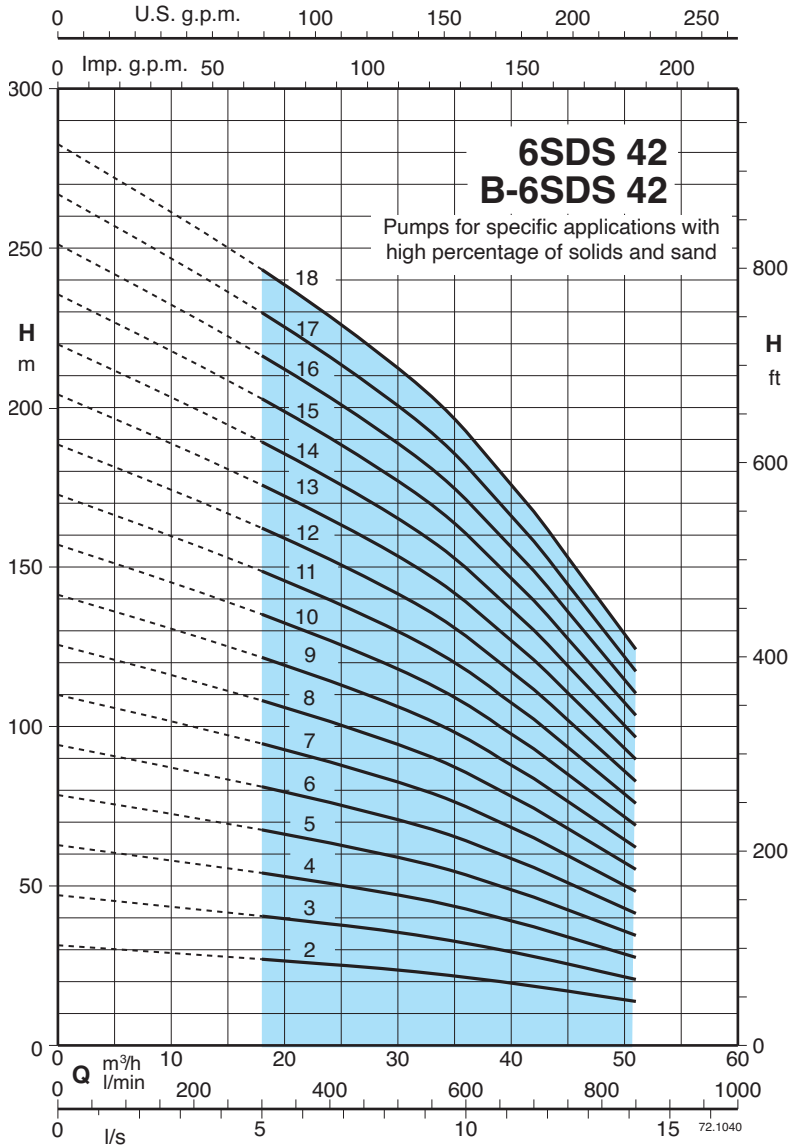

3 ~	P ₂		Q	n ≈ 2900 rpm											
	kW	HP		H											
				m³/h	18	24	30	33	36	39	42	45	48	51	
6SDS 42/2 - B-6SDS 42/2	4	5,5	l/min	27	25,5	23,5	22,5	21,5	20	18,5	17	15,5	14		
6SDS 42/3 - B-6SDS 42/3	5,5	7,5		40	38	35,5	34	32	30	28	25,5	23	21		
6SDS 42/4 - B-6SDS 42/4	7,5	10		53,5	51	47	45	43	40	37	34	31	27,5		
6SDS 42/5 - B-6SDS 42/5	9,2	12,5		67	63,5	59	56,5	53,5	50	46,5	42,5	38,5	34,5		
6SDS 42/6 - B-6SDS 42/6	11	15		80,5	76	71	68	64	60	56	51	46	41,5		
6SDS 42/7 - B-6SDS 42/7	13 (15)	17,5 (20)		94	89	82,5	79	75	70	65	59,5	54	48		
6SDS 42/8 - B-6SDS 42/8	15	20		107	101	94,5	90,5	85,5	80	74,5	68	61,5	55		
6SDS 42/9 - B-6SDS 42/9	15	20		120	114	106	102	96	90	84	76,5	69	62		
6SDS 42/10 - B-6SDS 42/10	18,5	25		134	127	118	113	107	100	93	85	77	69		
6SDS 42/11 - B-6SDS 42/11	18,5	25		147	140	130	124	118	110	102	93,5	85	76		
6SDS 42/12 - B-6SDS 42/12	22	30		161	152	141	135	128	120	111	102	92,5	83		
6SDS 42/13 - B-6SDS 42/13	22	30		174	165	153	147	139	130	121	110	100	90		
6SDS 42/14 - B-6SDS 42/14	26 (30)	35 (40)		187	178	165	158	150	140	130	119	108	96,5		
6SDS 42/15 - B-6SDS 42/15	26 (30)	35 (40)		201	190	177	169	160	150	139	127	115	103		
6SDS 42/16 - B-6SDS 42/16	30	40		214	203	189	181	171	160	149	136	123	110		
6SDS 42/17 - B-6SDS 42/17	30	40		228	216	200	192	182	170	158	144	131	117		
6SDS 42/18 - B-6SDS 42/18	30	40		241	228	212	203	192	180	167	153	138	124		

DN	f	6SDS	B-6SDS
	mm	kg	kg
G 3 ISO 228	584	25,5	29,5
	686	31,6	36,6
	788	36	42
	890	40,3	48,3
	992	47	59
	1094	50,5	65,5
	1196	55,5	66,5
	1298	62,5	74,5
	1400	69	81
	1502	74	86
	1604	79,2	94,2
	1706	83,2	99,2
	1808	91,4	106
	1910	96,4	113
2012	101	119	
2114	106	126	
2216	111	132	

Characteristic curves, performance $n \approx 2900$ rpm, dimensions and weights

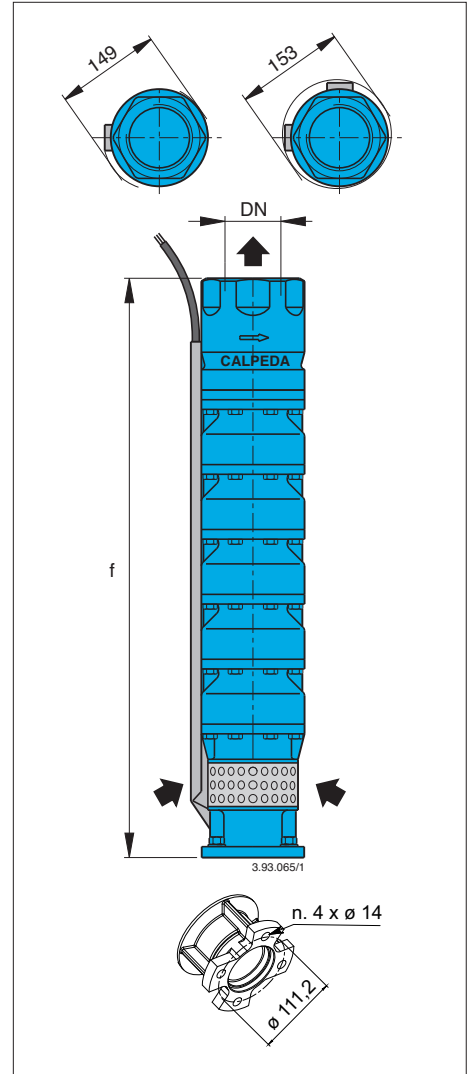
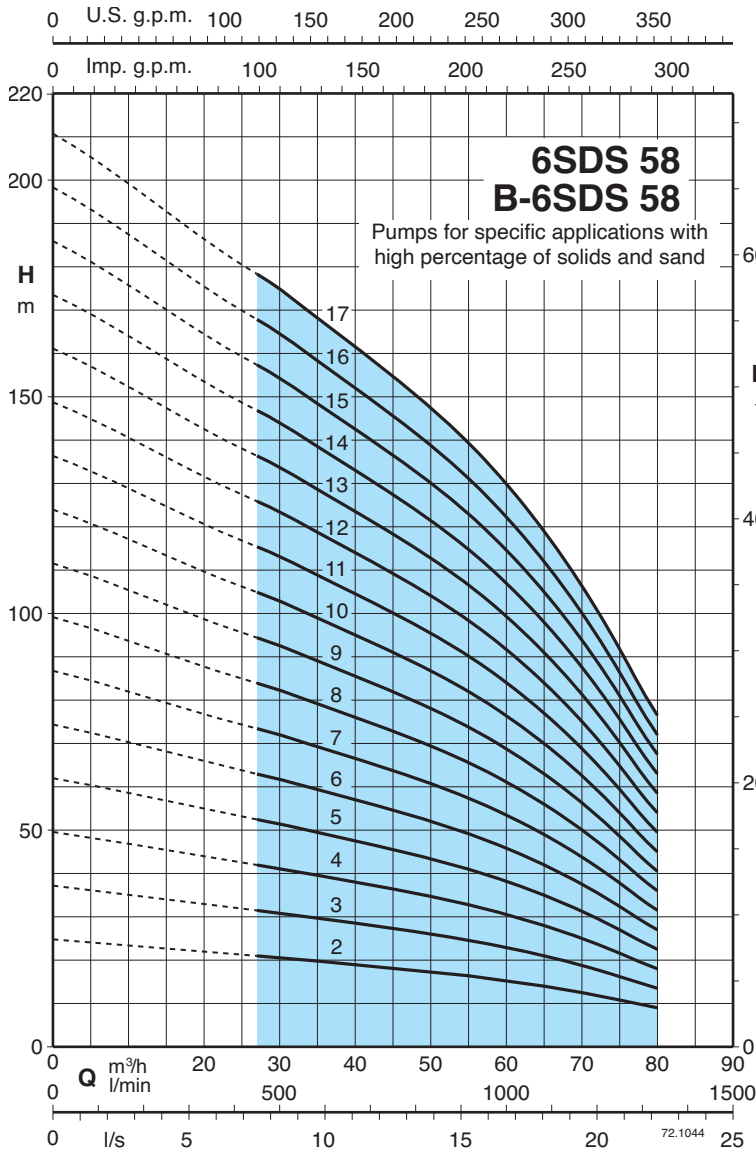

3 ~	P ₂		Q	n \approx 2900 rpm										
				m³/h										
	kW	HP	l/min	27	35	40	45	50	55	60	65	70	75	80
6SDS 58/2 - B-6SDS 58/2	4	5,5	H m	21	20	19	18	17	16,5	15,5	14	12,5	11	9
6SDS 58/3 - B-6SDS 58/3	5,5	7,5		32	30	28,5	27	26	24,5	23	21	18,5	16	13,5
6SDS 58/4 - B-6SDS 58/4	7,5	10		42,5	39,5	38	36	34,5	33	31	28	25	21,5	18
6SDS 58/5 - B-6SDS 58/5	9,2	12,5		53	49,5	47,5	45	43	41	38,5	35	31	27	22,5
6SDS 58/6 - B-6SDS 58/6	11	15		63,5	59,5	57	54	51,5	49	46	42	37	32,5	27
6SDS 58/7 - B-6SDS 58/7	13 (15)	17,5 (20)		74	69,5	66,5	63	60	57,5	54	49	43,5	38	31,5
6SDS 58/8 - B-6SDS 58/8	15	20		85	79	76	72	69	66	62	56	49,5	43	36
6SDS 58/9 - B-6SDS 58/9	18,5	25		95,5	89	85,5	81	77,5	74	69,5	63	56	49	40,5
6SDS 58/10 - B-6SDS 58/10	18,5	25		106	99	95	90	86	82	77	70	62	54	45
6SDS 58/11 - B-6SDS 58/11	22	30		117	109	104	99	94,5	90	85	77	68	59,5	49,5
6SDS 58/12 - B-6SDS 58/12	22	30		127	119	114	108	103	100	94,5	86,5	76,5	66,5	55,5
6SDS 58/13 - B-6SDS 58/13	26 (30)	35 (40)		138	129	123	117	112	107	100	91	80,5	70	58,5
6SDS 58/14 - B-6SDS 58/14	26 (30)	35 (40)		148	139	133	126	120	115	108	98	87	75,5	63
6SDS 58/15 - B-6SDS 58/15	30	40		159	148	142	135	129	123	115	105	93	81	67,5
6SDS 58/16 - B-6SDS 58/16	30	40		170	158	152	144	138	131	123	112	99	86,5	72
6SDS 58/17 - B-6SDS 58/17	30	40		180	168	162	153	146	139	131	119	105	92	76,5

DN	f	6SDS	B-6SDS
	mm	kg	kg
G 4 ISO 228	584	26,5	29,5
	686	31,6	36,6
	788	37	43
	890	43,3	50,3
	992	48	57
	1094	53,5	63,5
	1196	59,5	70,5
	1298	65	77
	1400	71	84
	1502	76,2	90,2
	1604	82,2	97,2
	1706	87,4	104
	1808	93,4	111
	1910	99,4	118
2012	104	124	
2114	110	131	

P₂ Rated motor power output

(...) FK motor rated power output

H Total head in m

Tolerances according to UNI EN ISO 9906:2012

8SDS 70

Submersible borehole pumps for 8" wells



Characteristic curves, performance $n \approx 2900$ rpm, dimensions and weights

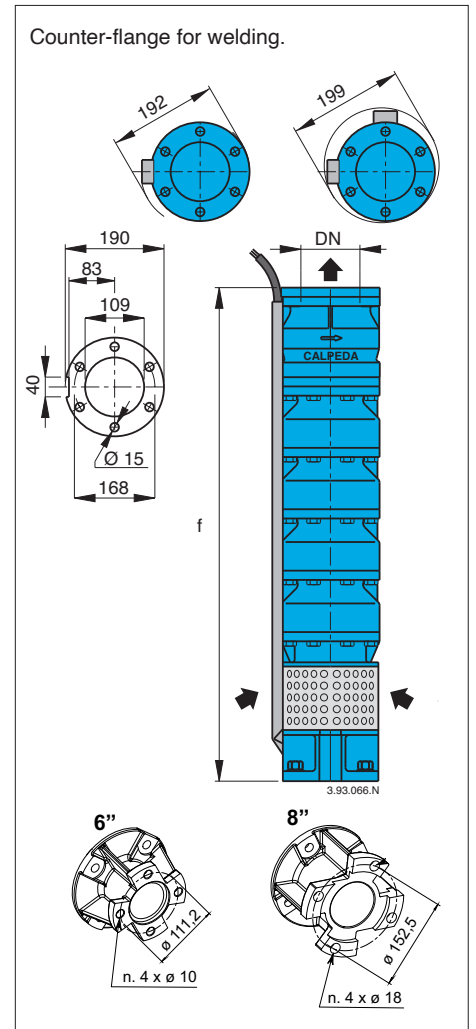
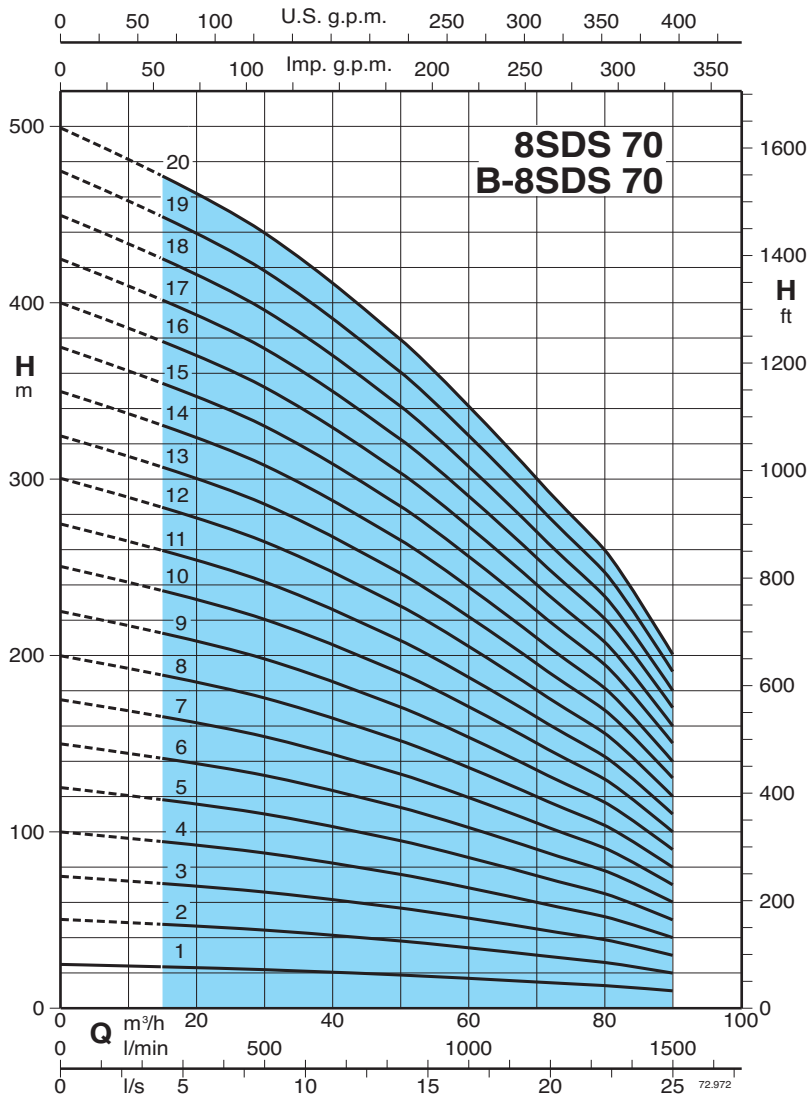

3 ~	P ₂		Q	n ≈ 2900 rpm													
	kW	HP		m³/h	H m												
					15	20	30	40	50	60	70	80	90	100			
8SDS 70/1 - B-8SDS 70/1	5,5	7,5	23,5	23	22	20,5	19	17	15	13	10						
8SDS 70/2 - B-8SDS 70/2	9,2	12,5	47	46	44	41	38	34	30	26	20						
8SDS 70/3 - B-8SDS 70/3	15	20	70,5	69	66	61,5	57	51	45	39	30						
8SDS 70/4 - B-8SDS 70/4	18,5	25	94	92	88	82	76	68	60	52	40						
8SDS 70/5 - B-8SDS 70/5	22	30	118	115	110	102	95	85	75	65	50						
8SDS 70/6 - B-8SDS 70/6	26 (30)	35 (40)	141	138	132	123	114	102	90	78	60						
8SDS 70/7 - B-8SDS 70/7	30	40	165	161	154	143	133	119	105	91	70						
8SDS 70/8 - B-8SDS 70/8	37	50	188	184	176	164	152	136	120	104	80						
8SDS 70/9 - B-8SDS 70/9	45	60	212	207	198	184	171	153	135	117	90						
8SDS 70/10 - B-8SDS 70/10	45	60	235	230	220	205	190	170	150	130	100						
8SDS 70/11 - B-8SDS 70/11	51 (55)	70 (75)	259	253	242	225	209	187	165	143	110						
8SDS 70/12 - B-8SDS 70/12	55	75	282	276	264	246	228	204	180	156	120						
8SDS 70/13 - B-8SDS 70/13	59 (75)	80 (100)	306	299	286	266	247	221	195	169	130						
8SDS 70/14 - B-8SDS 70/14	59 (75)	80 (100)	329	322	308	287	266	238	210	182	140						
8SDS 70/15 - B-8SDS 70/15	66 (75)	90 (100)	353	345	330	307	285	255	225	195	150						
8SDS 70/16 - B-8SDS 70/16	75	100	376	368	352	328	304	272	240	208	160						
8SDS 70/17 - B-8SDS 70/17	75	100	400	391	374	348	323	289	255	221	170						
8SDS 70/18 - B-8SDS 70/18	92	125	423	414	396	369	342	306	270	234	180						
8SDS 70/19 - B-8SDS 70/19	92	125	447	437	418	389	361	323	285	247	190						
8SDS 70/20 - B-8SDS 70/20	92	125	470	460	440	410	380	340	300	260	200						

DN	Motor		f	8SDS	B-8SDS
	CS-R mm	FK mm			
100	145 6"	137 6"	602	38	43
			734	49	55,5
			866	60	68
			998	71,5	80,5
			1130	82,5	93
			1262	93,5	106
	191 8"	196 8"	1394	105	118
			1526	116	131
			1658	127	143
			1790	138	156
			1922	149	168
			2054	160	181
191 8"	196 8"	2186	171	194	
		2318	182	206	
		2450	193	219	
		2582	205	231	
		2714	216	244	
		2846	227	256	
			2978	238	269
			3110	249	281

P₂ Rated motor power output

(...) FK motor rated power output

H Total head in m

Tolerances according to UNI EN ISO 9906:2012

8SDS 100

Submersible borehole pumps for 8" wells



Characteristic curves, performance $n \approx 2900$ rpm, dimensions and weights

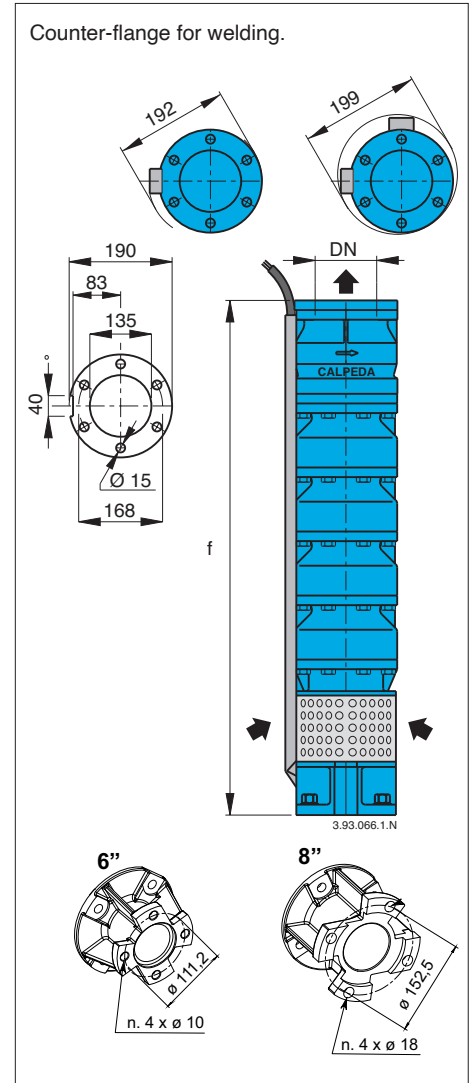
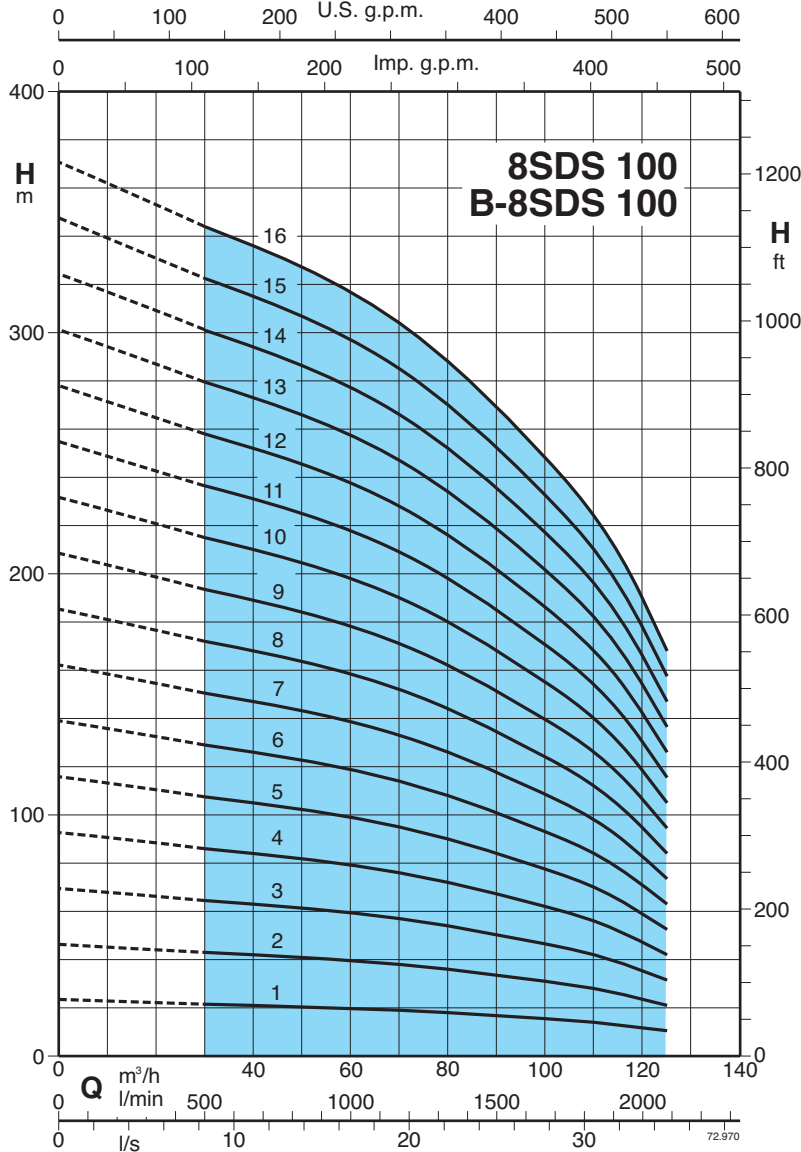

3 ~	P2		Q	$n \approx 2900$ rpm										
	kW	HP		m³/h	30	40	50	60	70	80	90	100	110	125
				l/min	500	666	833	1000	1166	1333	1500	1666	1833	2083
8SDS 100/1 - B-8SDS 100/1	5,5	7,5	H m	21,5	21	20,5	20	19	18	17	15,5	14	10,5	
8SDS 100/2 - B-8SDS 100/2	11	15		43	42	41	40	38	36	34	31	28	21	
8SDS 100/3 - B-8SDS 100/3	18,5	25		64,5	63	61,5	60	57	54	51	46,5	42	31,5	
8SDS 100/4 - B-8SDS 100/4	22	30		86	84	82	80	76	72	68	62	56	42	
8SDS 100/5 - B-8SDS 100/5	30	40		107	105	102	100	95	90	85	77,5	70	52,5	
8SDS 100/6 - B-8SDS 100/6	37	50		129	126	123	120	114	108	102	93	84	63	
8SDS 100/7 - B-8SDS 100/7	45	60		150	147	143	140	133	126	119	108	98	73,5	
8SDS 100/8 - B-8SDS 100/8	45	60		172	168	164	160	152	144	136	124	112	84	
8SDS 100/9 - B-8SDS 100/9	51 (55)	70 (75)		193	189	184	180	171	162	153	139	126	94,5	
8SDS 100/10 - B-8SDS 100/10	55	75		215	210	205	200	190	180	170	155	140	105	
8SDS 100/11 - B-8SDS 100/11	66 (75)	90 (100)		236	231	225	220	209	198	187	170	154	115	
8SDS 100/12 - B-8SDS 100/12	66 (75)	90 (100)		258	252	246	240	228	216	204	186	168	126	
8SDS 100/13 - B-8SDS 100/13	75	100		279	273	266	260	247	234	221	201	182	136	
8SDS 100/14 - B-8SDS 100/14	92	125		301	294	287	280	266	252	238	217	196	147	
8SDS 100/15 - B-8SDS 100/15	92	125		322	315	307	300	285	270	255	232	210	157	
8SDS 100/16 - B-8SDS 100/16	92	125		344	336	328	320	304	288	272	248	224	168	

DN	Motor		f	8SDS	B-8SDS
	CS-R mm	FK mm			
125	145 6"	137 6"	602	38	43
			734	49	55
			866	59	67
			998	70	79
			1130	81	91
			1262	92	103
	191 8"	196 8"	1394	102	115
			1526	113	128
			1658	124	140
			1790	135	152
			1922	145	164
			2054	156	176
			2186	167	188
			2318	177	200
			2450	188	212
			2582	199	224

P2 Rated motor power output

(...) FK motor rated power output

H Total head in m

Tolerances according to UNI EN ISO 9906:2012

8SDS 150

Submersible borehole pumps for 8" wells



Characteristic curves, performance $n \approx 2900$ rpm, dimensions and weights

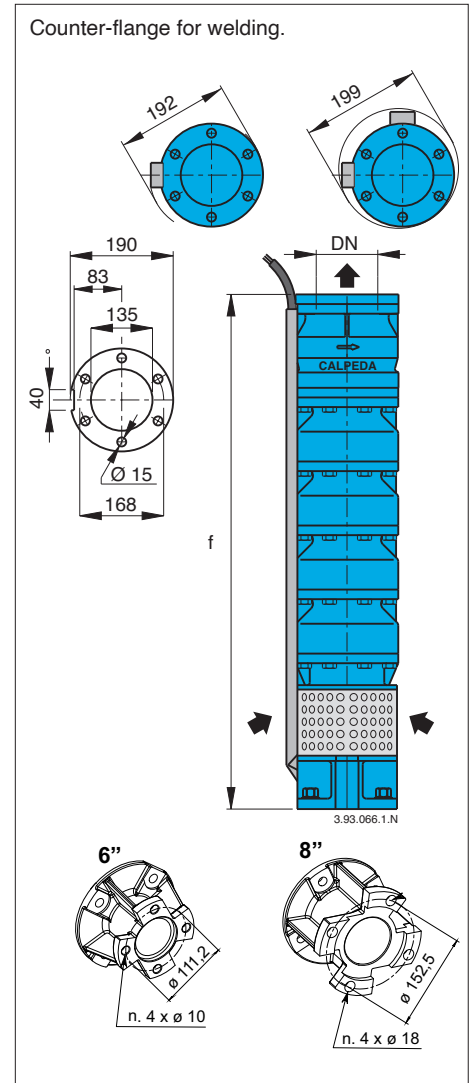
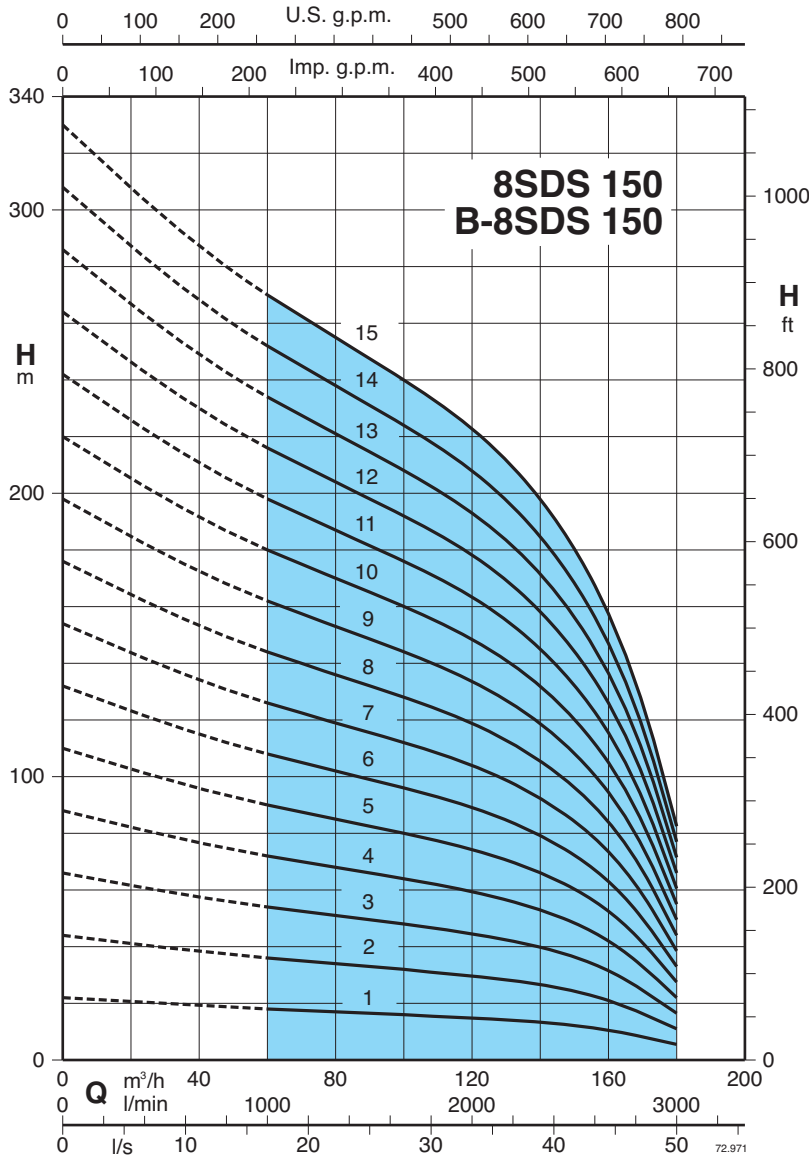

3 ~	P ₂		Q	n ≈ 2900 rpm											DN	Motor		f	8SDS	B-8SDS				
	kW	HP		m³/h	60	70	80	90	100	110	125	140	150	160		180	CS-R				FK	mm	kg	kg
					l/min	1000	1166	1333	1500	1666	1833	2083	2333	2500		2666								
8SDS 150/1 - B-8SDS 150/1	7,5	10	H m	18	17,5	17	16,5	16	15,5	14,5	13	11,5	10,5	5,5	125	145 6"	137 6"	602	38	43				
8SDS 150/2 - B-8SDS 150/2	15	20		36	35	34	33	32	31	29	26	23	21	11				734	49	55,5				
8SDS 150/3 - B-8SDS 150/3	22	30		54	52,5	51	49,5	48	46,5	43,5	39	34,5	31,5	16,5				866	60	68				
8SDS 150/4 - B-8SDS 150/4	30	40		72	70	68	66	64	62	58	52	46	42	22				998	71,5	80,5				
8SDS 150/5 - B-8SDS 150/5	37	50		90	87,5	85	82,5	80	77,5	72,5	65	57,5	52,5	27,5				1130	82,5	93				
8SDS 150/6 - B-8SDS 150/6	45	60		108	105	102	99	96	93	87	78	69	63	33		1262	93,5	106						
8SDS 150/7 - B-8SDS 150/7	51 (55)	70 (75)		126	122	119	115	112	108	101	91	80,5	73,5	38,5		1394	105	118						
8SDS 150/8 - B-8SDS 150/8	59 (75)	80 (100)		144	140	136	132	128	124	116	104	92	84	44		1526	116	131						
8SDS 150/9 - B-8SDS 150/9	66 (75)	90 (100)		162	157	153	148	144	139	130	117	103	94,5	49,5		1658	127	143						
8SDS 150/10 - B-8SDS 150/10	75	100		180	175	170	165	160	155	145	130	115	105	55		1790	138	156						
8SDS 150/11 - B-8SDS 150/11	92	125		198	192	187	181	176	170	159	143	126	115	60,5		196 8"	1922	149	168					
8SDS 150/12 - B-8SDS 150/12	92	125		216	210	204	198	192	186	174	156	138	126	66			2054	160	181					
8SDS 150/13 - B-8SDS 150/13	110	150		234	227	221	214	208	201	188	169	149	136	71,5			2186	171	194					
8SDS 150/14 - B-8SDS 150/14	110	150		252	245	238	231	224	217	203	182	161	147	77			2318	182	206					
8SDS 150/15 - B-8SDS 150/15	110	150		270	262	255	247	240	232	217	195	172	157	82,5			2450	193	219					

P₂ Rated motor power output

(...) FK motor rated power output

H Total head in m

Tolerances according to UNI EN ISO 9906:2012

Characteristic curves, performance $n \approx 2900$ rpm, dimensions and weights

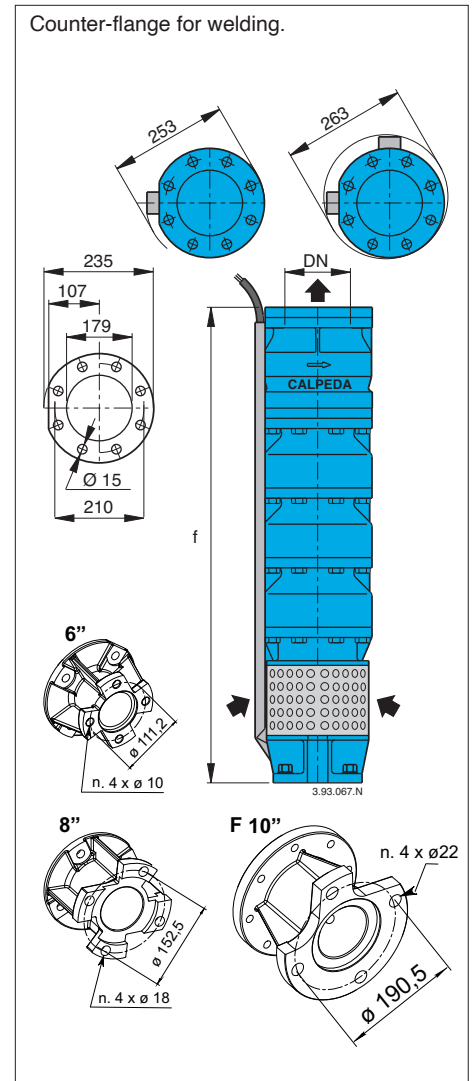
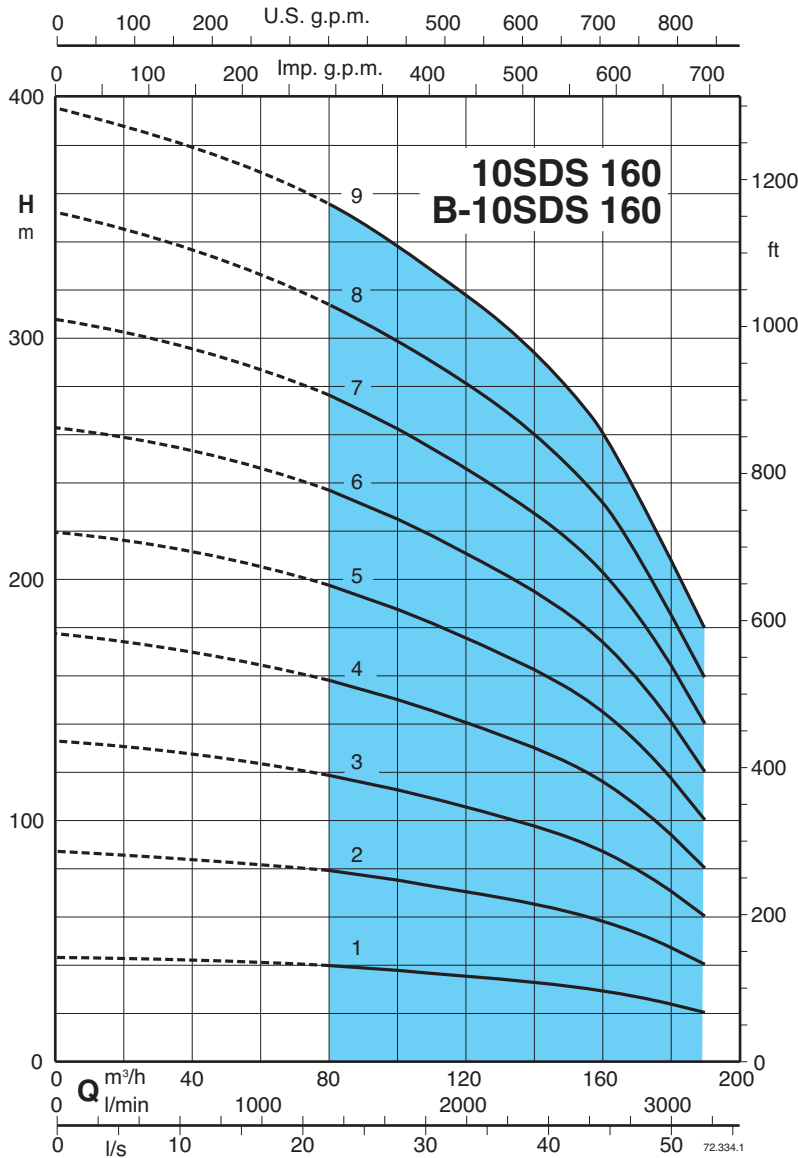

3 ~	P ₂		Q	n ≈ 2900 rpm												DN	Motor		f	10SDS	B-10SDS				
	kW	HP		m³/h	H												CS-R mm	FK mm				mm	kg	kg	
					l/min	1333	1500	1666	1833	2083	2333	2500	2666	2833	3000										3166
10SDS 160/1 - B-10SDS 160/1	18,5	25	39,5	38	37,5	36	34,5	32,5	31	29	26,5	22	20	175	145 6"	137 6"	865	77	87						
10SDS 160/2 - B-10SDS 160/2	37	50	78,5	76,5	74,5	72,5	69	65	62	58,5	53,5	44	40				1205	103	114						
10SDS 160/3 - B-10SDS 160/3	55	75	118	114	112	108	104	98	92,5	87,5	80	66,5	60				1205	126	141						
10SDS 160/4 - B-10SDS 160/4	75	100	157	153	149	145	138	130	123	117	107	88,5	80		1375	150	169								
10SDS 160/5 - B-10SDS 160/5	92	125	196	191	186	181	173	163	154	146	134	111	100		1545	173	195								
10SDS 160/6 - B-10SDS 160/6	110	150	236	229	224	217	207	195	185	175	160	133	120		1715	197	222								
10SDS 160/7 - B-10SDS 160/7	130	175	275	267	261	253	242	228	216	204	187	155	140		1885	220	249								
10SDS 160/8 - B-10SDS 160/8	150	200	314	305	298	289	276	260	246	233	213	177	160		2055	244	276								
10SDS 160/9 - B-10SDS 160/9	185	250	356	342	338	324	311	293	279	261	239	198	180		2225	268	303								

P₂ Rated motor power output

(...) FK motor rated power output

H Total head in m

Tolerances according to UNI EN ISO 9906:2012

10SDS 280

Submersible borehole pumps for 10" wells



Characteristic curves, performance $n \approx 2900$ rpm, dimensions and weights

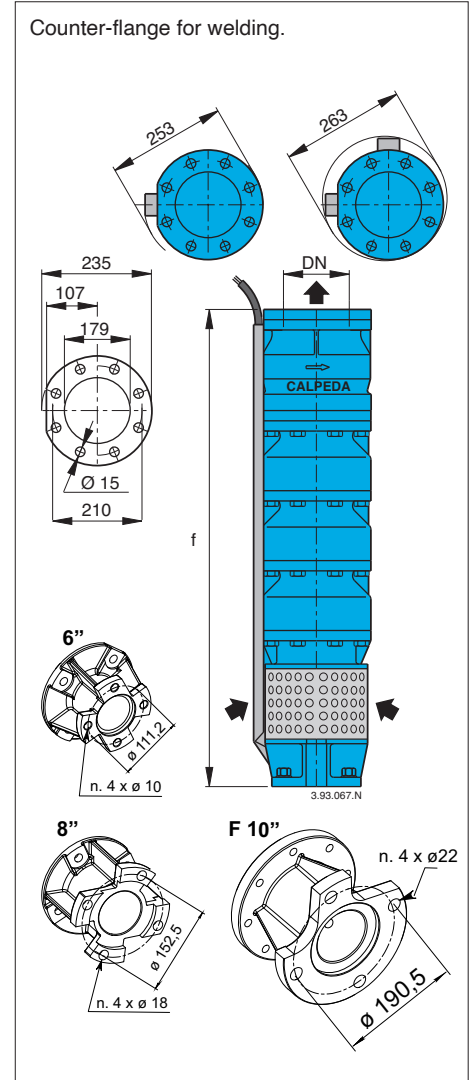
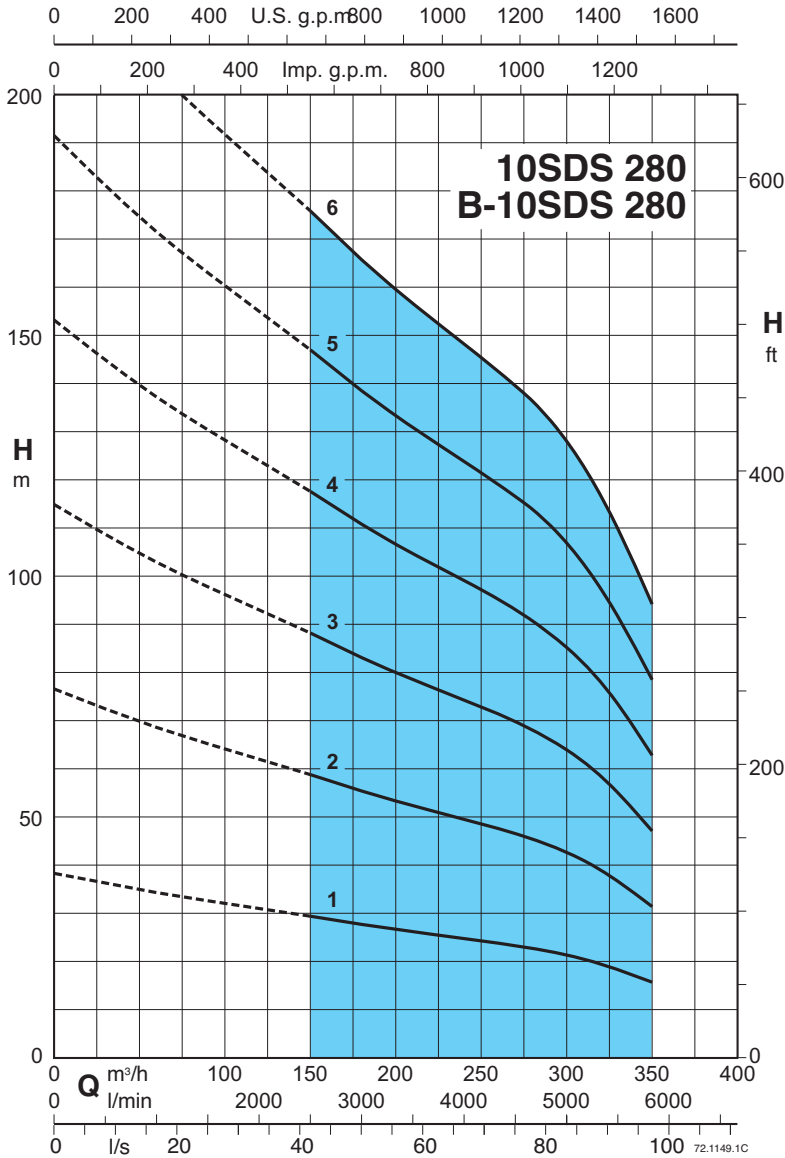

3 ~	P ₂		Q	n ≈ 2900 rpm											DN	Motor		f	10SDS	B-10SDS	
																CS-R	FK				
	kW	HP		m³/h	150	180	200	220	240	260	280	300	315	350		mm	mm				mm
			l/min	2500	3000	3333	3666	4000	4333	4666	5000	5250	5833								
10SDS 280/1 - B-10SDS 280/1	26 (30)	35 (40)	H	29	28	27	26	25	24	23	21	20	16	175	145-6"	137-6"	196	8"	865	78	88
10SDS 280/2 - B-10SDS 280/2	55	75	m	59	55	53	51	50	48	46	42	40	31						1035	103	116
10SDS 280/3 - B-10SDS 280/3	75	100		88	83	80	77	75	71	69	64	60	47						1205	127	143
10SDS 280/4 - B-10SDS 280/4	110	150		118	111	106	103	100	95	92	85	80	63						1375	151	170
10SDS 280/5 - B-10SDS 280/5	130	175		147	139	133	129	125	119	115	106	100	79						1545	175	198
10SDS 280/6 - B-10SDS 280/6	150	200		176	167	160	155	150	143	138	127	120	95						1715	199	226

P₂ Rated motor power output

(...) FK motor rated power output

H Total head in m

Tolerances according to UNI EN ISO 9906:2012

Cables connection kit

It allows connection of electric cables with junction submerged in water.

The kit includes:

- 4 connectors
- 4 shrink-sheaths for protection of individual wires
- 1 shrink-sheath for protection of the 4-pole wire.

The sheath shrinks with heating (flame or drier) which causes resin outlet granting connection waterproofing.



Installation examples

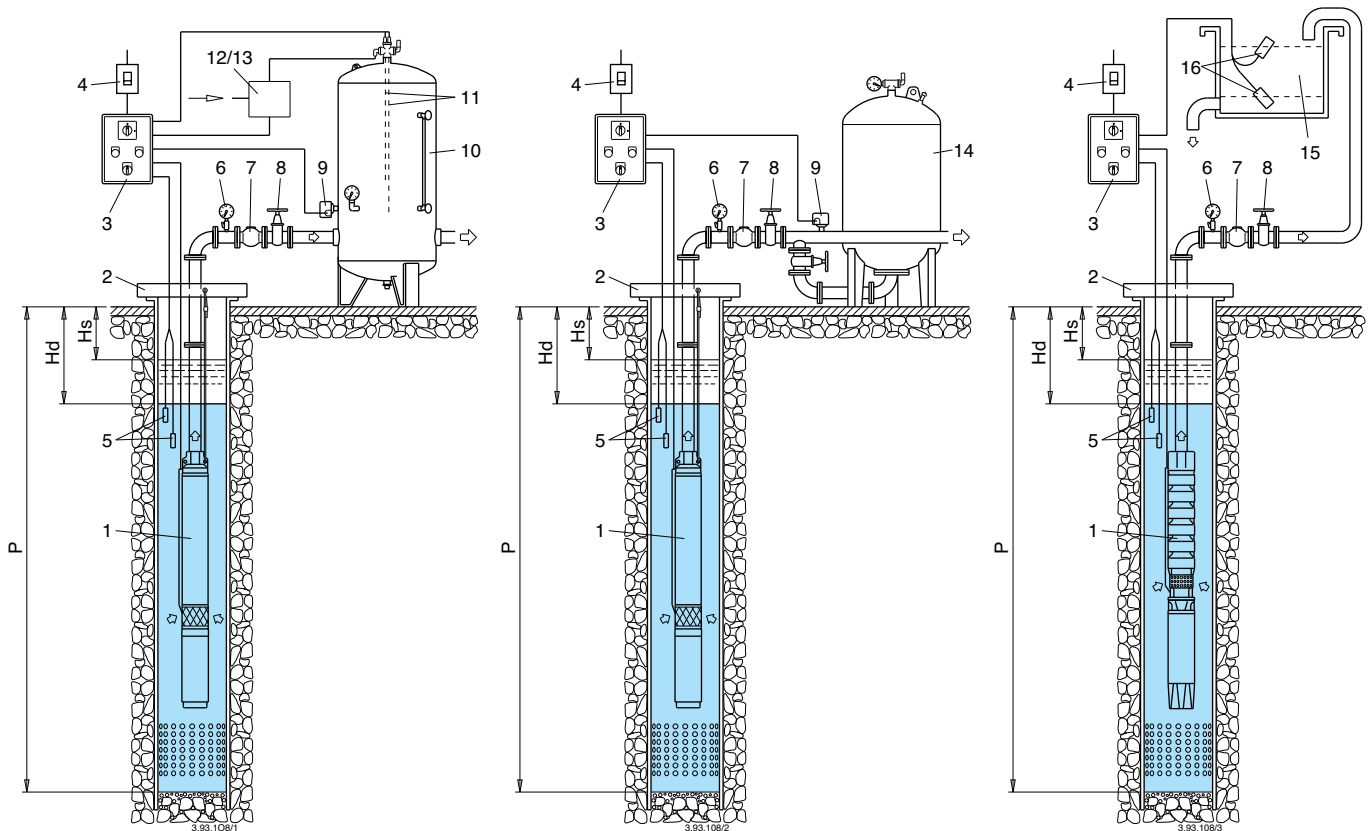

- 1 Submersible pump
- 2 Pump support system
- 3 Electric control board
- 4 Circuit breaker
- 5 Minimum level probes
- 6 Pressure gauge
- 7 Check valve
- 8 Throttle gate valve
- 9 Pressure switch
- 10 Pressure tank
- 11 Probes for air entry control
- 12 Electric valve
- 13 Compressor
- 14 Membrane tank
- 15 Storage tank
- 16 Start-stop probes

Hs Static level
 Hd Dynamic level
 P Tubewell depth